



KRENDL™
The Innovator in Insulation Equipment



OWNERS MANUAL

MODEL #325



50 YEARS OF QUALITY AND SERVICE

**KRENDL MACHINE COMPANY • 1201 SPENCERVILLE AVE
DELPHOS, OHIO 45833 • TELEPHONE 419-692-3060 • FAX 419-695-9301
E - MAIL: krendl@krendlmachine.com • WEB SITE: www.krendlmachine.com**

CONGRATULATIONS ON YOUR PURCHASE OF KRENDL EQUIPMENT

**MODEL #325
OWNER'S MANUAL**

FOR ASSURED SAFETY AND CONFIDENCE, PLEASE READ THIS MANUAL CAREFULLY BEFORE INSTALLING AND OPERATING YOUR MACHINE.

**E-MAIL ADDRESS IS: krendl@krendlmachine.com
WEB SITE IS: www.krendlmachine.com**

Table of Contents

	PAGE
INTRODUCTION.....	1
GENERAL SAFETY INFORMATION.....	2-3
DECALS.....	4-5
WARRANTY.....	6
RETURNED GOODS PROCEDURE and SPECIFICATIONS	7
BASIC COMPONENTS.....	8
OPERATING INSTRUCTIONS.....	9-12
TROUBLESHOOTING.....	13
ELECTRICAL.....	14-16
LADDER DIAGRAM.....	17-19
PARTS LIST.....	20-24
GLOSSARY.....	25
SERVICE RECORD.....	26

INTRODUCTION

Thank you for purchasing a **KRENDL INSULATION MOVING MACHINE**. With over fifty-five years experience in manufacturing insulation moving equipment, we have designed and built your machine with the highest quality to provide years of reliable service.

This manual has been prepared to help you obtain the maximum efficiency and service from your Krendl equipment. The machine is designed to condition and apply insulation with the utmost in dependable performance. Our primary objective is to build equipment which will provide complete satisfaction so that you may confidently recommend Krendl to others.

We do not manufacture or sell insulation. Our interest lies only in the proper performance of the equipment we manufacture. We make no recommendations or guarantees concerning various insulations.

CAUTION:



This manual contains important information regarding the **safe** assembly and operation of your machine. We urge you to read it carefully and follow the instructions provided. If your questions are not answered in this manual, may we hear from you? We want you to be able to operate this unit safely and confidently.

UNPACKING: Store and unpack carton with correct side up. Unpack your machine **IMMEDIATELY** and check for damage in shipping. **Place any damage claim with delivering carrier, saving all packing materials for inspection.** Our warranty covers manufacturer's defects only. **DO NOT** return to shipper.

FILL IN AND RETAIN:

Krendl Machine Company
1201 Spencerville Ave.
Delphos, Ohio 45833 U.S.A.

Telephone: 419-692-3060
Fax: 419-695-9301
E-mail: krendl@krendlmachine.com
Web Site: www.krendlmachine.com

For your protection in the event of theft or loss, please fill in the information requested for your own records. This information will be needed for in-warranty repairs. You may also want to attach a copy of your invoice.

Machine model number _____ Blower motor manufacturer _____

Serial number _____ Gear motor manufacturer _____

Blower(s) serial number(s) _____ Gear motor serial number _____

Supplier _____ Date of purchase _____

The model and machine serial numbers are located on the hopper of the machine unit. The blower and gearmotor serial numbers are located on the motor housing of each unit.

GENERAL SAFETY INFORMATION

 **Important:** Read **all** instructions **before** operating this unit. This equipment can be potentially dangerous and must be used in strict accordance with instructions.

 **Disclaimer Notice:** The manufacturer will not be legally responsible for any injury or damage resulting from the improper use of this equipment or the failure to follow instructions.

Unpacking

Handle cartons with care to avoid damage from dropping or bumping. Store and unpack cartons with the correct side up. Completely remove machine from the packaging and from any shipping pallet or skid to which it might be attached. In addition, completely remove all shipping materials from **inside** the machine including wheel package, manual, ect....



General Safety

1. Read this manual carefully and become familiar with your machine unit. Know its applications, limitations, and any hazards involved.
2. This machine was designed and manufactured for specific applications. Do not attempt to modify the unit or use it for any application it was not designed for. If you have any questions about your intended use or the machines suitability, ask your dealer/distributor or consult the factory. The manufacturers' could not possibly anticipate every circumstance that might involve a hazard. For that reason, warnings in the manual and warning tags or decals affixed to the unit, are **not** all-inclusive. If you intend to handle, operate, or service the unit by a procedure or method not specifically recommended by the manufacturer, first make sure that such a procedure or method will not render this equipment unsafe or pose a threat to you and others.



Electrical Safety

- The **National Electric Code** (NEC) in the United States and many international electrical codes require frame and external electrically conductive parts of this machine to be properly connected to an approved earth ground. Local electrical codes may also require proper grounding of machine. Consult with local electricians for grounding requirements in your area.
- Never handle any kind of electrical cord or device while standing in water, while barefoot or while hands or feet are wet. Dangerous electrical shock will result.
- Use a ground fault circuit interrupter (GFCI) in any damp or highly conductive area. (metal decking or steel work)
- Reference NFPA 79, 70E, or OSHA safe work practices when performing energized work procedures.



Safety/Caution

- **Be Safe** - Keep away from moving parts.
- **Be Safe** - Make sure all guards and hopper bar are in proper place **before** operating machine. Guards and safety devices/switches should not be removed, modified or by-passed. Hands should **never** pass below hopper bar.
- **Be Safe** - Do not remove motors or lift hopper when unit is connected to power supply.
- **Be Safe** - Make sure machine is properly grounded. Protect all electrical supply cords from sharp objects, moisture, and other potentially hazardous materials. Keep power cords in good repair. Electrical service must be performed by a qualified electrician.
- **Be Safe** - Disconnect power supply **before** inspecting or adjusting unit.
- **Be Safe** - Consult a qualified technician to answer questions **before** attempting to operate, or injury may result.
- **Be Safe** - Do not operate machine alone.
- **Be Safe** - Do not leave machine unattended and energized.
- **Be Safe** - Turn machine off and disconnect electricity before clearing and feeding jam or attempting to remove any object dropped in the hopper.
- **Be Safe** - Keep hands, loose clothing, jewelry and hair away from agitators, gears, chains and other moving parts.
- **Be Safe** - Use proper lifting when moving insulation and loading machine.
- **Be Safe** - Keep work area clear of debris.
- **Be Safe** - Wear proper safety equipment, including protective gear, such as respirators, eye and ear protection.
- **Be Safe** - Violation of the Owner's Manual or safety precautions may void warranty.



Make Sure!

- Hopper is empty of foreign objects **before** starting.
- Adequate electrical power is supplied or damage to unit will result.
- Blower filter is kept clean and in place when blower is on.
- Machine is turned off **immediately** if hose is plugged, or blower will overheat.
- Machine must be on **before** adding insulation.
- Blower(s) must be on, when agitators are running, or machine will bind.
- Agitator motor is not run with hopper empty for more than a few minutes, or damage to seals will result.
- Sprockets, chains, belts and pulleys are correctly **aligned** and **tensioned**.
- Pieces of bag are **not** left in the machine as this can bind and stall your machine.
- This machine should only be used with good quality insulations that are dry, undamaged and that meet a certain industry specification or quality standards.

DECALS



Keeping the filter clean will result in longer blower life and better performances.



Rotating parts can be dangerous! You can snag clothes, hair, hands, etc. This can cause serious injury or death.

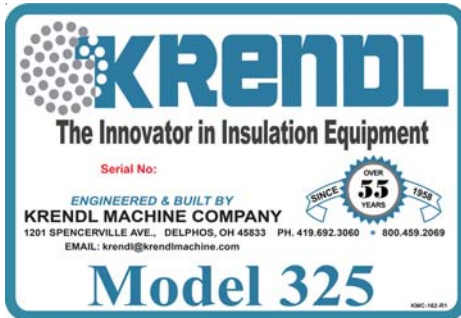

Manufacturer information is provided here along with machine model, and serial number.



Indicates which employee inspected the equipment and on what date.

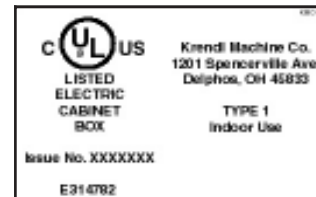

Indicates that the electrical box on the machine is in compliance with UL codes.



Rotating parts will be moving in this direction.



Part number for identification and tracking.



Made in the U.S.A.

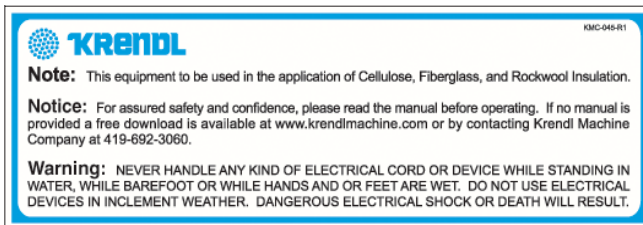

Identifies what type of insulation should be used with this machine and that the manual should be read before operating. Warns to be careful around electrical components! This can cause serious injury or death.



A list of warnings intended to reduce the risk of serious injury or death.



General safety information intended to reduce the risk of serious injury or death

U.S. (Basic)

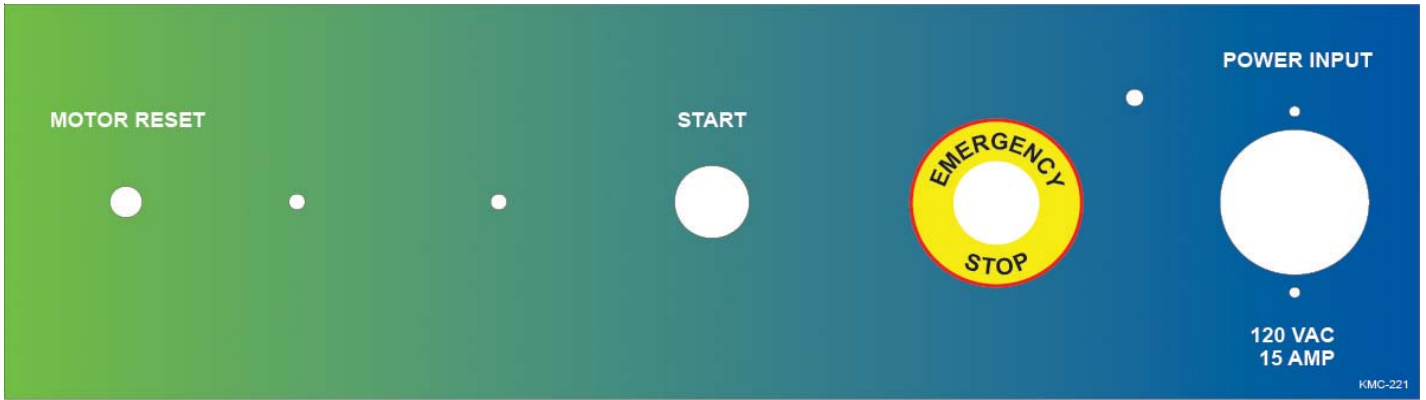

U.S.

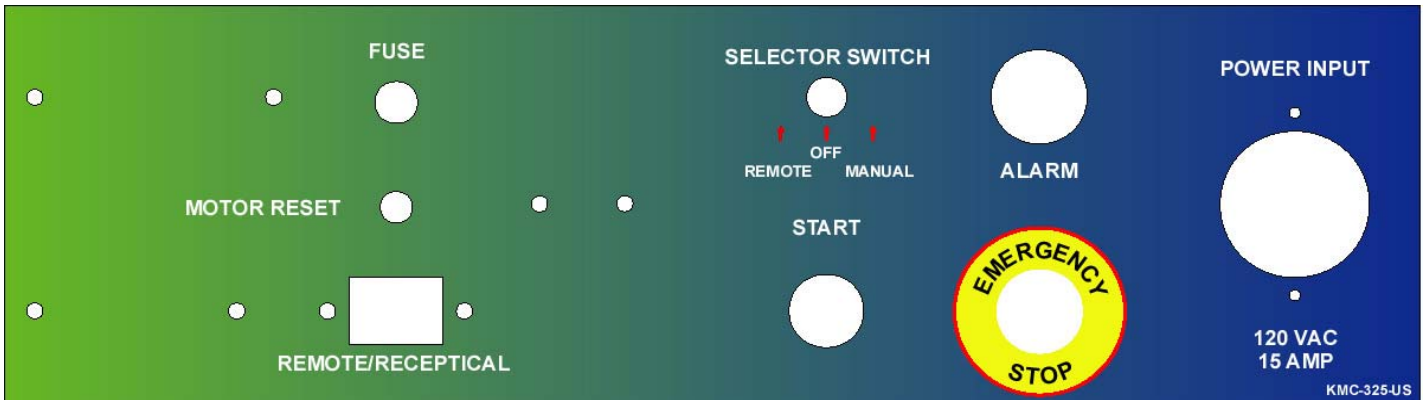

Overseas



Indicates the controls that start, stop, and run the machine.

WARRANTY:

Krendl Machine Company (Company) warrants to each original purchaser (Buyer) of its machines that such products will be free of manufacturing defects for a period of 2 years from the date of shipment to the Buyer. (This does not include accessories, pumps, blowers, wall scrubbers, etc.)

No warranty is made with respect to:

1. Components or accessories manufactured and warranted by others. Warranties for purchased component parts as supplied from vendor such as engine, electric motor, blower, gearbox, transmission, etc., if furnished by the manufacturer of the component, are on file at the Company's main office and copies will be furnished at request of Buyer. Component(s), shipping costs prepaid, shall be sent to Company who in turn shall forward to vendor for evaluation and warranty determination.
2. Any defect caused by repair, alteration and/or adjustment performed by Buyer or customer/ vendor of Buyer without the express written authorization of the Company.
3. The labor costs of replacing parts by parties other than the Company.
4. Any machine that has not been operated and/or maintained in accordance with normal industry practice and the written recommendations of the Company. (e.g. machine operated with an improperly sized, worn or damaged hose, improper or inattention to preventative maintenance, etc.)
5. The product has been subjected to misuse, negligence or accident or results of any application or use of the blowing equipment not in accordance with the Company recommendations.

This limited warranty does not cover the free replacement of component parts that become inoperative due to wear and usage and need to be replaced on a regular basis, including but not limited to: airlock seal(s), agitator(s), shredder(s), auger(s), fuse(s), switch(es), clutch(es), hose(s), shaft seal(s), chain(s), belt(s), sprocket(s), pulley(s), bearing(s), cable(s), battery(ies), filter(s), fan(s), etc.

The Company's obligation under this warranty is limited to repairing or replacing (at Company option) any part that is determined by the Company to be suffering from a manufacturing defect. The Company (at Company option) will provide any required parts and labor to the Buyer. If the equipment or parts must be returned to the Company for repair, all transportation costs shall be the Buyer's responsibility.

THIS LIMITED WARRANTY IS EXPRESSLY IN LIEU OF ANY OTHER GUARANTEES AND / OR WARRANTIES, ORAL OR WRITTEN, EXPRESSED OR IMPLIED, INCLUDING WITHOUT LIMITATION, THE IMPLIED WARRANTY OF MERCHANTABILITY. NO WARRANTY, EXPRESS OR IMPLIED, OTHER THAN THE AFORESAID WARRANTY IS MADE OR AUTHORIZED BY COMPANY. COMPANY SHALL NOT BE LIABLE FOR ANY DIRECT, INDIRECT, INCIDENTAL OR CONSEQUENTIAL DAMAGES TO PROPERTY OR INJURY TO ANY PERSON OR COSTS ASSOCIATED WITH LOSS OF PRODUCTION RESULTING IN LOSS OF REVENUE, PROFITS OR LOSS OF EQUIPMENT THROUGH THE USE OF THIS EQUIPMENT.

Note: Special job circumstances incurring costs for specialized repair and next day delivery of parts will not be reimbursed by the manufacturer unless authorized by factory.

RETURNED GOODS PROCEDURE:

IF MACHINE WAS NOT PURCHASED DIRECTLY FROM KRENDL MACHINE COMPANY, CONTACT YOUR SUPPLIER / DISTRIBUTOR.

When returning products to Krendl for repair, first obtain a return goods authorization, at which time you will be given shipping instructions. The product must be shipped **PREPAID**:

Krendl Machine Company
1201 Spencerville Ave.
Delphos, Ohio 45833 U.S.A.

Telephone: 419-692-3060
Fax: 419-695-9301
E-mail: krendl@krendlmachine.com
Web Site: www.krendlmachine.com

Once the unit is received, it will be inspected. In-warranty units will be repaired and returned immediately. An estimate of repair charges will be provided for out-of-warranty units.

SPECIFICATIONS

MODEL#:	325
MACHINE:	8" Diameter x 8" Length airlock (20.3 cm Diameter x 20.3 cm Length airlock) In line helical gear motor (driving the machine)
HEIGHT:	49 1/2" (126 cm)
WIDTH (DEPTH):	29 1/2" (75 cm)
LENGTH:	28 1/2" (72 cm)
WEIGHT:	145 pounds (66 kg)
ELECTRICAL:	120VAC, 15 amp, single input 230VAC, 16 amp, single input
BLOWER VOLUME:	104 CFM
BLOWER PRESSURE:	2.0 PSI maximum
HOSE OUTPUT:	2.5" diameter (6.3 cm diameter)
MAXIMUM FEED RATES:	
CELLULOSE:	900 lbs./hr.

WARNING: Recommended hose size, type and length must be used to achieve maximum results. Krendl cannot guarantee performance of the machine if hoses are undersized, worn, damaged, or hoses other than those we recommend are used.

BEFORE YOU RUN THIS MACHINE...PLEASE READ THE REST OF THIS MANUAL!!

BASIC COMPONENTS: #325

This is a view of the basic components of your #325 machine. It shows the location of each item and gives the function of each. Use this as a guide throughout the manual.

- A) BASE UNIT / HOPPER**—Hopper/base unit supports blower, gear motor and airlock.
- B) AIRLOCK**—Traps air and insulation while providing a metered flow.
- C) GEAR MOTOR**—Provides driving power of agitation system. Increases output power while decreasing speed of the agitators and airlock.
- D) AGITATORS (2)**—Conditions insulation in the hopper.
- E) MAIN CONTROL PANEL**—Connects with main power, allowing operation of unit at machine.
- F) BLOWER**—(Not shown) Creates air pressure to blow insulation out of airlock.
- G) HOPPER BAR**—Hinders operators from reaching agitators.

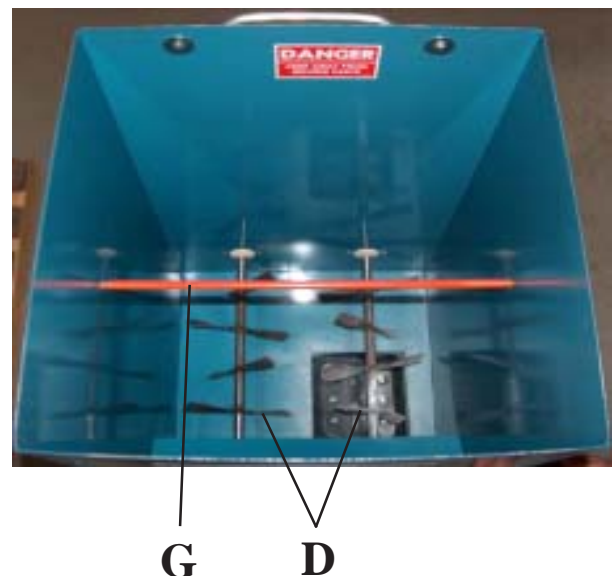
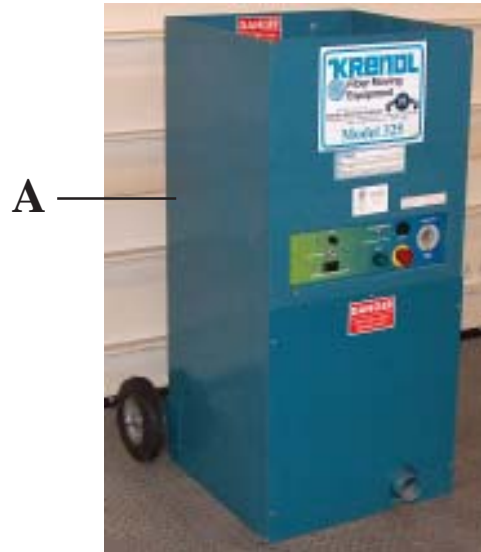

OPERATING INSTRUCTIONS (120V U.S.)

1. Read all safety and operating instructions before operating this unit.
2. This unit comes ready for connection with hose, clamps, and power cord. (Not supplied)
3. This unit provides a direct hook-up to 2 1/2" I.D. hose. Slide hose on blower outlet and secure with a hose clamp to provide safe working conditions. All hose connections should have hose clamps to prevent air leakage and separation of hose.
4. This unit is supplied with power through a 120V Flush Mount Input Plug located on the Control Panel.
Note: When using extension cord, wire gauge size should not be less than 12-3 and not exceed 50' in length. (See Voltage Drop Chart Below.)

VOLTAGE DROP CHART									
Typical voltage drop values based on conductor size and one-way length* (60 C termination and insulation)									
25 FEET									
		12 AWG	10 AWG	8 AWG	6 AWG	4 AWG	3 AWG	2 AWG	1 AWG
AMPERES	20	1.98	1.24	0.78	0.49	0.31	0.25	0.19	0.15
	30		1.86	1.17	0.74	0.46	0.37	0.29	0.23
	40			1.56	0.98	0.62	0.49	0.39	0.31
	50				1.23	0.77	0.61	0.49	0.39
	60					0.93	0.74	0.58	0.46
50 FEET									
		12 AWG	10 AWG	8 AWG	6 AWG	4 AWG	3 AWG	2 AWG	1 AWG
AMPERES	20	3.95	2.49	1.56	0.98	0.62	0.49	0.39	0.31
	30		3.73	2.34	1.47	0.93	0.74	0.58	0.46
	40			3.13	1.97	1.24	0.98	0.78	0.62
	50				2.46	1.55	1.23	0.97	0.77
	60					1.85	1.47	1.17	0.92
75 FEET									
		12 AWG	10 AWG	8 AWG	6 AWG	4 AWG	3 AWG	2 AWG	1 AWG
AMPERES	20	5.93	3.73	2.34	1.47	0.93	0.74	0.58	0.46
	30		5.59	3.52	2.21	1.39	1.1	0.87	0.69
	40			4.69	2.95	1.85	1.47	1.17	0.92
	50				3.69	2.32	1.84	1.46	1.16
	60					2.78	2.21	1.75	1.39
100 FEET									
		12 AWG	10 AWG	8 AWG	6 AWG	4 AWG	3 AWG	2 AWG	1 AWG
AMPERES	20	7.90	4.97	3.13	1.97	1.24	0.98	0.78	0.62
	30		7.46	4.69	2.95	1.85	1.47	1.17	0.92
	40			6.25	3.93	2.47	1.96	1.56	1.23
	50				4.92	3.09	2.45	1.94	1.54
	60					3.71	2.94	2.33	1.85
125 FEET									
		12 AWG	10 AWG	8 AWG	6 AWG	4 AWG	3 AWG	2 AWG	1 AWG
AMPERES	20	9.88	6.21	3.91	2.46	1.55	1.23	0.97	0.77
	30		9.32	5.86	3.69	2.32	1.84	1.46	1.16
	40			7.81	4.92	3.09	2.45	1.94	1.54
	50				6.15	3.86	3.06	2.43	1.93
	60					4.64	3.68	2.92	2.31
150 FEET									
		12 AWG	10 AWG	8 AWG	6 AWG	4 AWG	3 AWG	2 AWG	1 AWG
AMPERES	20	11.85	7.46	4.69	2.95	1.85	1.47	1.17	0.92
	30		11.18	7.03	4.42	2.78	2.21	1.75	1.39
	40			9.38	5.90	3.71	2.94	2.33	1.85
	50				7.37	4.64	3.68	2.92	2.31
	60					5.56	4.41	3.50	2.77

Ex: A two-wire 20-ampere circuit using 12 AWG with a one-way distance of 25 feet will drop 1.98 volts;
 120 volts - 1.98 volts = 118.02 volts as the load voltage.
 240 volts - 1.98 volts = 238.02 volts as the load voltage.

OPERATING INSTRUCTIONS (120V U.S.) (Continued)

5. When assembling unit, make sure emergency stop button is pushed in. Hook up electrical supply. **Caution:** Operating unit with less than required voltage, more than required voltage, or inadequate generator size will result in damage to electrical components. This machine is marked on the Main Control Panel with the correct input voltage required. **Note:** Agitator motor and blower should only be operated with steady or constant flow of electricity between 110-120 volts. **Do not** operate machine with less than or more than required voltage. Damage to motors and other electrical parts will result, voiding warranty.
6. **Never** place machine where airflow may be blocked which will cause blower failure.
7. This unit has a main control panel that has a three position selector switch as follows. (**NOTE:** This main control panel will be referred to as the **CONTROL PANEL.**) (See Illustration A)

LEFT POSITION
REMOTE / RECYCLE

CENTER POSITION
OFF

RIGHT POSITION
Manual

Automatic side of switch which operates the **BLOWER MOTOR** on with **AGITATOR MOTOR** with the 24 Volt AC signal of another machine.

Manual side which operates the **BLOWER MOTOR** and the **AGITATOR MOTOR** when the start button is pressed.

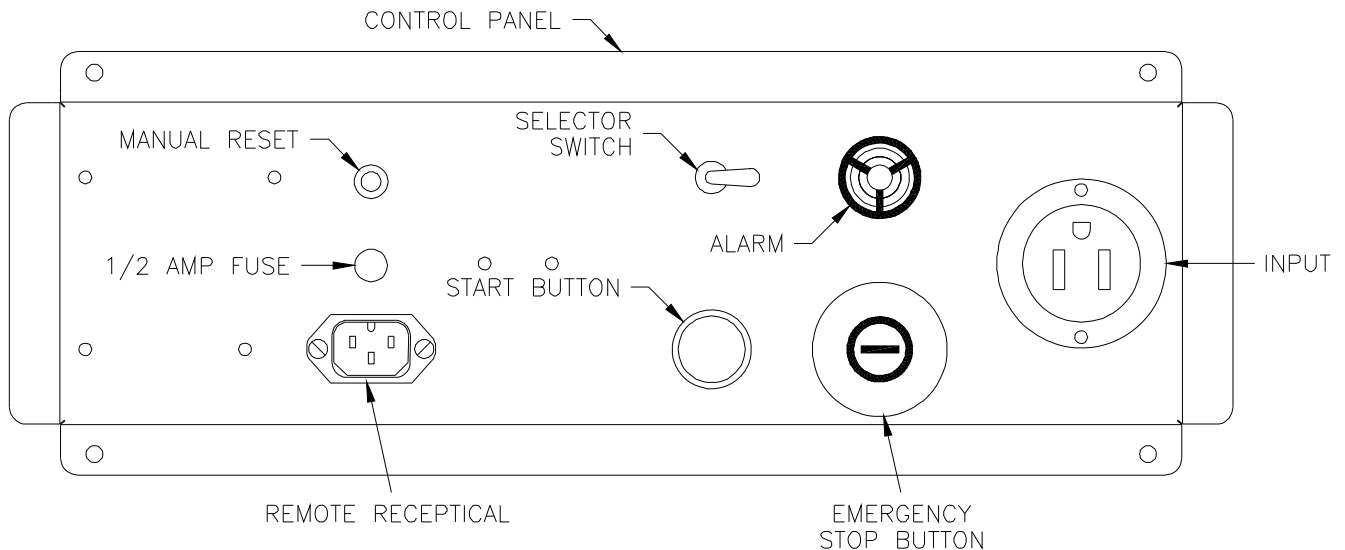

Illustration A

8. This machine is equipped with an emergency stop button for your safety. This button must be pulled out and the start button must be pressed for the machine to start. (See Illustration A)
9. Fill hopper with insulation. The first bag of insulation in the hopper should be well broken by hand to assist agitator action. **Caution: NEVER** put hands below hopper bar or force-feed material by pushing down on insulation.
10. At the end of the workday, empty the hopper and use the machine to **BLOW OUT THE HOSE.**

OPERATING INSTRUCTIONS (230V Overseas)

1. Read all safety and operating instructions before operating this unit.
2. This unit comes ready for connection with hose, clamps, and power cord. (Not supplied)
3. This unit provides a direct hook-up to 2 1/2" I.D. hose. Slide hose on blower outlet and secure with a hose clamp to provide safe working conditions. All hose connections should have hose clamps to prevent air leakage and separation of hose.
4. This unit is supplied with power through a 230V drop cord located on the side of the machine. **Note: When using extension cord, wire gauge size should not be less than 12-3 and not exceed 50' in length. (See Voltage Drop Chart Below.)**

VOLTAGE DROP CHART									
Typical voltage drop values based on conductor size and one-way length* (60 C termination and insulation)									
25 FEET									
		12 AWG	10 AWG	8 AWG	6 AWG	4 AWG	3 AWG	2 AWG	1 AWG
AMPERES	20	1.98	1.24	0.78	0.49	0.31	0.25	0.19	0.15
	30		1.86	1.17	0.74	0.46	0.37	0.29	0.23
	40			1.56	0.98	0.62	0.49	0.39	0.31
	50				1.23	0.77	0.61	0.49	0.39
	60					0.93	0.74	0.58	0.46
50 FEET									
		12 AWG	10 AWG	8 AWG	6 AWG	4 AWG	3 AWG	2 AWG	1 AWG
AMPERES	20	3.95	2.49	1.56	0.98	0.62	0.49	0.39	0.31
	30		3.73	2.34	1.47	0.93	0.74	0.58	0.46
	40			3.13	1.97	1.24	0.98	0.78	0.62
	50				2.46	1.55	1.23	0.97	0.77
	60					1.85	1.47	1.17	0.92
75 FEET									
		12 AWG	10 AWG	8 AWG	6 AWG	4 AWG	3 AWG	2 AWG	1 AWG
AMPERES	20	5.93	3.73	2.34	1.47	0.93	0.74	0.58	0.46
	30		5.59	3.52	2.21	1.39	1.1	0.87	0.69
	40			4.69	2.95	1.85	1.47	1.17	0.92
	50				3.69	2.32	1.84	1.46	1.16
	60					2.78	2.21	1.75	1.39
100 FEET									
		12 AWG	10 AWG	8 AWG	6 AWG	4 AWG	3 AWG	2 AWG	1 AWG
AMPERES	20	7.90	4.97	3.13	1.97	1.24	0.98	0.78	0.62
	30		7.46	4.69	2.95	1.85	1.47	1.17	0.92
	40			6.25	3.93	2.47	1.96	1.56	1.23
	50				4.92	3.09	2.45	1.94	1.54
	60					3.71	2.94	2.33	1.85
125 FEET									
		12 AWG	10 AWG	8 AWG	6 AWG	4 AWG	3 AWG	2 AWG	1 AWG
AMPERES	20	9.88	6.21	3.91	2.46	1.55	1.23	0.97	0.77
	30		9.32	5.86	3.69	2.32	1.84	1.46	1.16
	40			7.81	4.92	3.09	2.45	1.94	1.54
	50				6.15	3.86	3.06	2.43	1.93
	60					4.64	3.68	2.92	2.31
150 FEET									
		12 AWG	10 AWG	8 AWG	6 AWG	4 AWG	3 AWG	2 AWG	1 AWG
AMPERES	20	11.85	7.46	4.69	2.95	1.85	1.47	1.17	0.92
	30		11.18	7.03	4.42	2.78	2.21	1.75	1.39
	40			9.38	5.90	3.71	2.94	2.33	1.85
	50				7.37	4.64	3.68	2.92	2.31
	60					5.56	4.41	3.50	2.77

Ex: A two-wire 20-ampere circuit using 12 AWG with a one-way distance of 25 feet will drop 1.98 volts; 230 volts - 1.98 volts = 228.02 volts as the load voltage.

OPERATING INSTRUCTIONS (230V Overseas) (Continued)

- When assembling unit, make sure emergency stop button is pushed in. Hook up electrical supply. **Caution:** Operating unit with less than required voltage, more than required voltage, or inadequate generator size will result in damage to electrical components. This machine is marked on the side of the machine with the correct input voltage required. **Note:** Agitator motor and blower should only be operated with steady or constant flow of electricity between 220-230 volts. **Do not** operate machine with less than or more than required voltage. Damage to motors and other electrical parts will result, voiding warranty.
- Never** place machine where airflow may be blocked which will cause blower failure.
- This unit has a main control panel that has a three position selector switch as follows. (**NOTE:** This main control panel will be referred to as the **CONTROL PANEL** and the toggle switch at the end of the remote cord as the **Remote Control Switch**.) (See Illustration B)

LEFT POSITION
REMOTE

CENTER POSITION
OFF

RIGHT POSITION
Manual

Operates the **BLOWER MOTOR** and **AGITATOR MOTOR** with the remote control switch after the start button is pressed.

Manual side which operates the **BLOWER MOTOR** and the **AGITATOR MOTOR** when the start button is pressed.

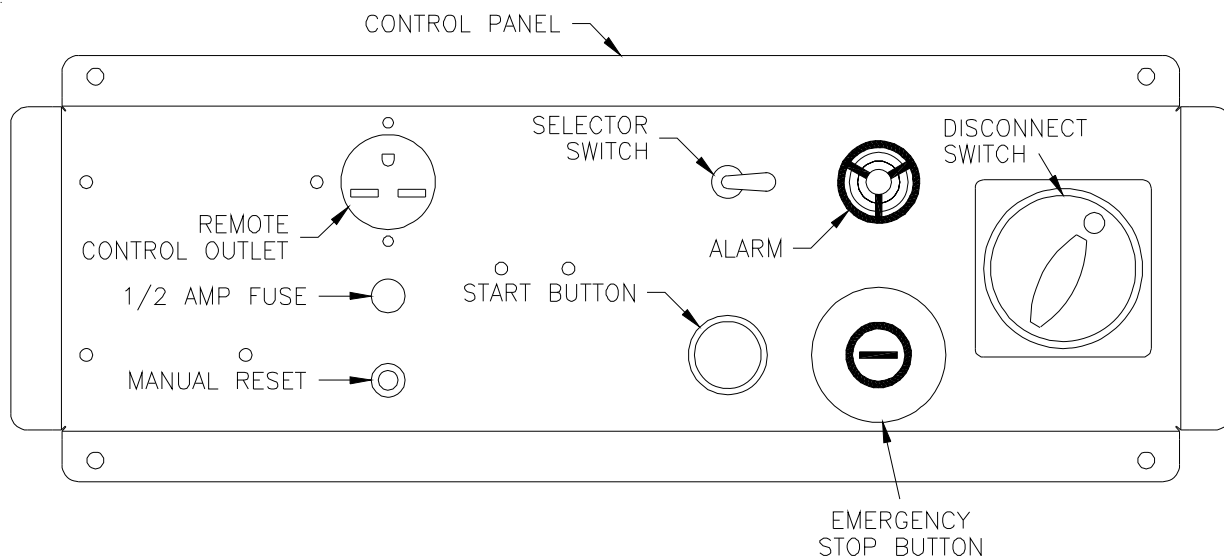

Illustration B

- This machine is equipped with an emergency stop button for your safety. This button must be pulled out and the start button must be pressed for the machine to start. (See Illustration B)
- Fill hopper with insulation. The first bag of insulation in the hopper should be well broken by hand to assist agitator action. **Caution: NEVER** put hands below hopper bar or force-feed material by pushing down on insulation.
- At the end of the workday, empty the hopper and use the machine to **BLOW OUT THE HOSE.**

TROUBLESHOOTING

IMPORTANT: DO NOT attempt to service unit. (Contact your dealer for further information.)

1. If machine does not run:
 - a. Make sure emergency stop button is pulled out and start button is pressed.
 - b. Check MOTOR RESET button. Press to reset. (See Illustration A or B)
 - c. Check power cords for proper connection.
 - d. Check 1/2 amp fuse. (See Illustration A or B)
2. Loud knocking sound: **(Unplug power supply)**
 - a. Check machine agitators and airlock for foreign objects.
 - b. Check for misaligned sprockets or loose chain.
3. Poor output from machine or uneven flow through hose: **(Unplug power supply)**
 - a. Check for material bridging in hopper.
 - b. Voltage may be low, try another electrical source. Use proper wire size for extension cord (#12-3).
 - c. Check for worn or damaged rubber airlock seals.
4. Blower motor running hot: **(Unplug power supply)**
 - a. Clean filter. Blow out surrounding area with air hose.
 - b. Check for restriction in blowing hose.
5. Agitator motor running hot: **(Unplug power supply)**
 - a. Check for insulation build up around motor and blow out with air hose.
 - b. Low voltage can cause this condition. Try another electrical source (#12-3).
 - c. Debris jamming airlock. Rotate airlock manually and clean out.
 - d. Check for sprocket misalignment and bearing wear.

ELECTRICAL

ELECTRICAL DIAGRAM: Periodically, disconnect machine from power source and check all electrical connections and components for broken or loose wires.

MODEL #325
120 V.A.C. — 60 Hz
BASIC

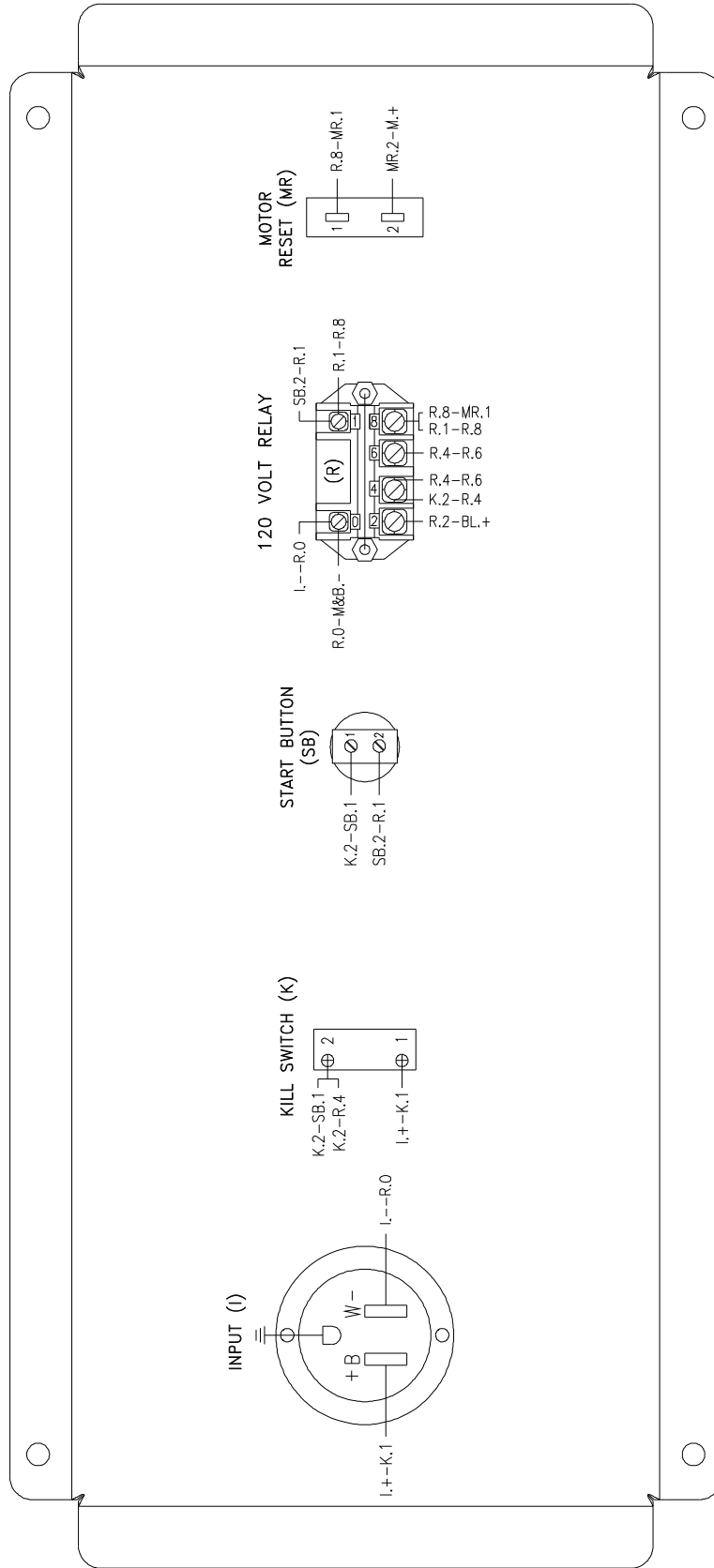

ELECTRICAL DIAGRAM: Periodically, disconnect machine from power source and check all electrical connections and components for broken or loose wires.

MODEL #325
230 V.A.C. — 50 Hz

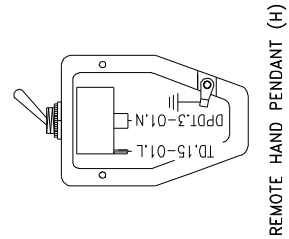
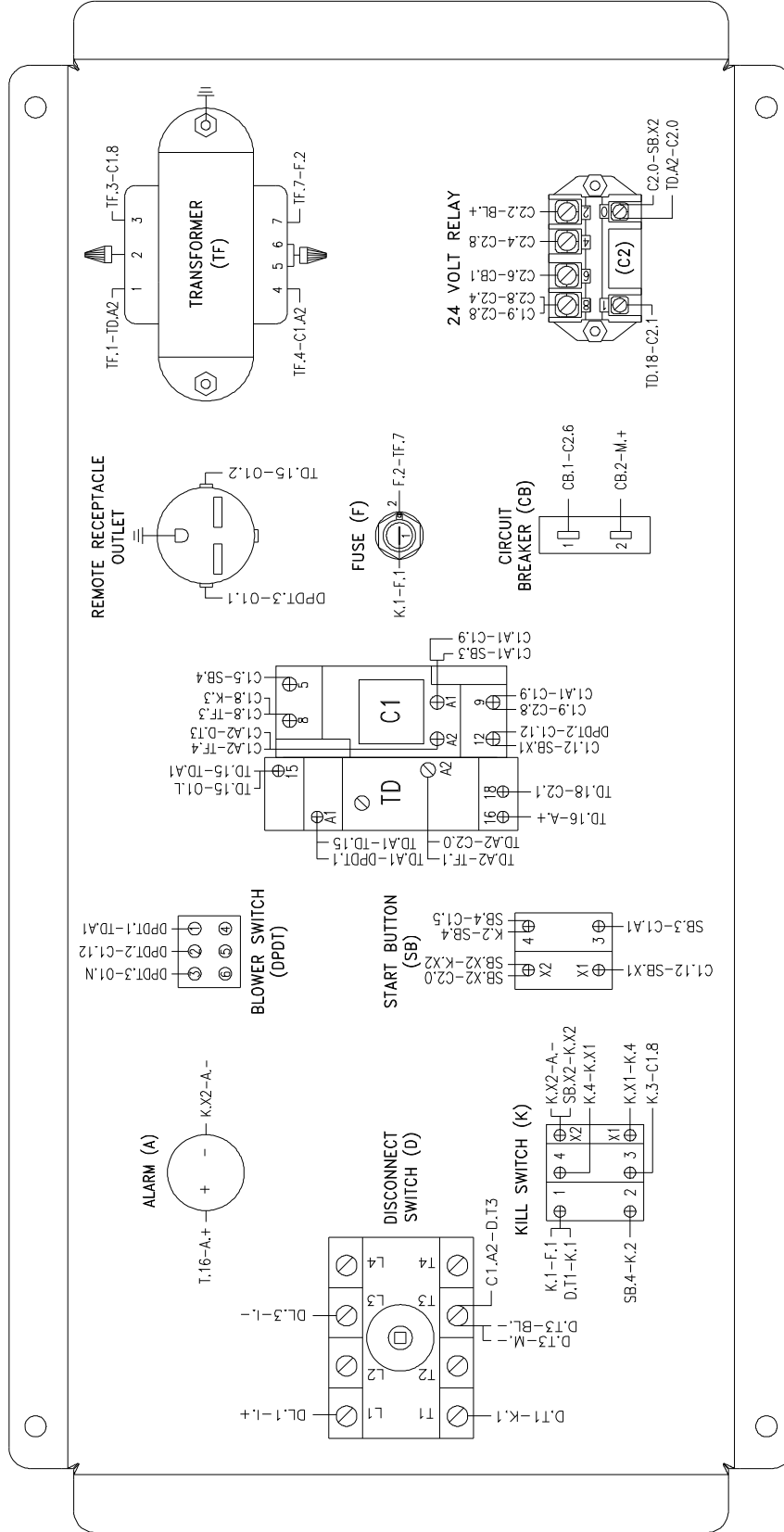

LADDER DIAGRAM

**MODEL #325
120 V.A.C. — 60 Hz
SINGLE INPUT
(BASIC)**

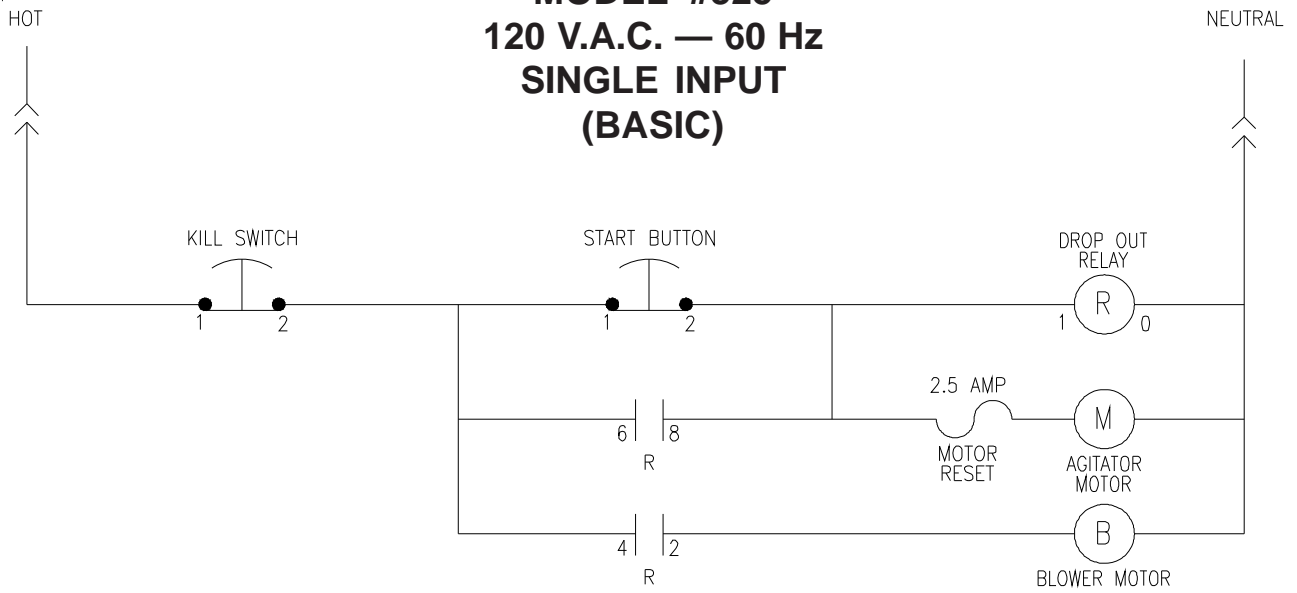

**MODEL #325
120 V.A.C. — 60 Hz
SINGLE INPUT**

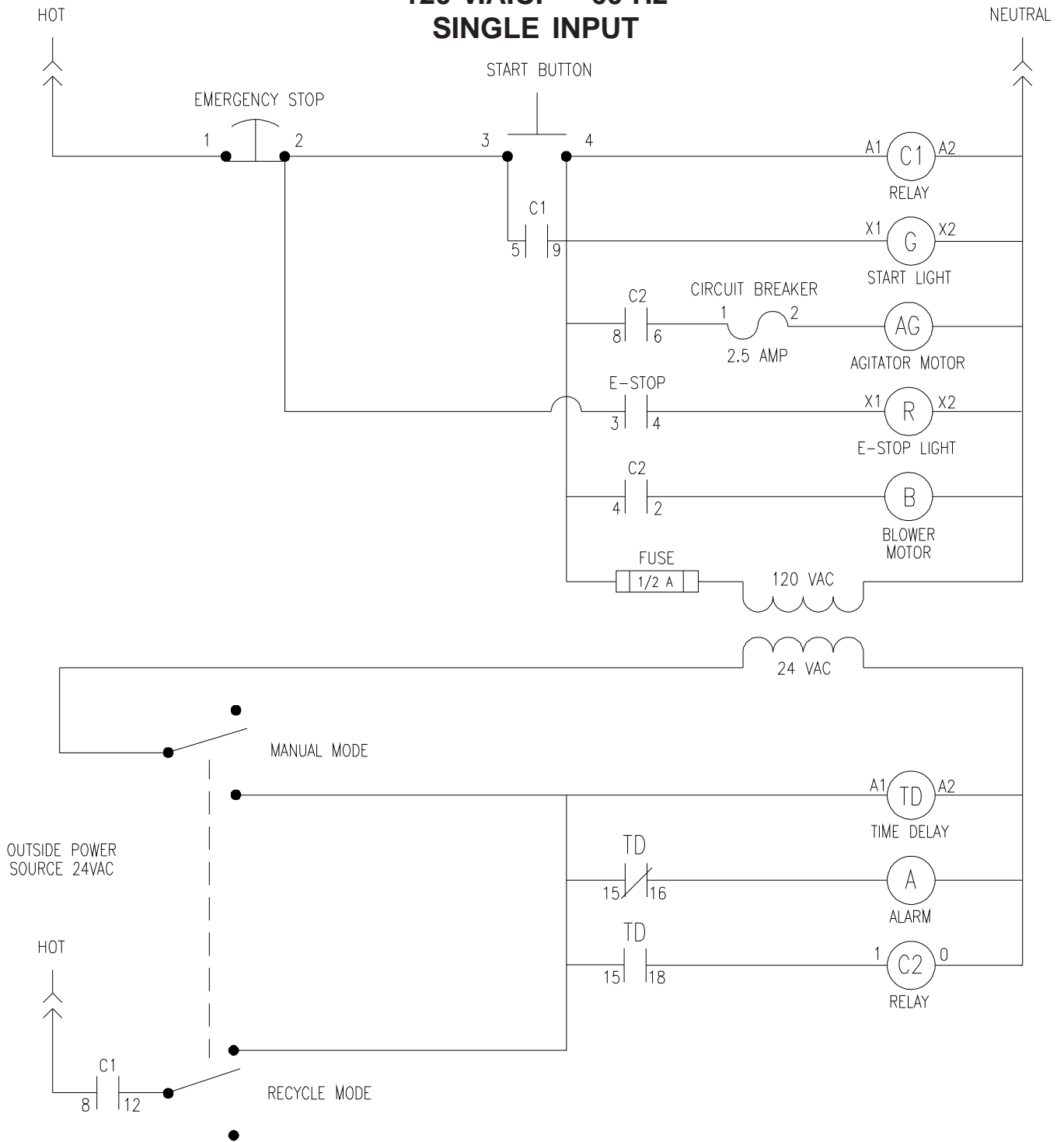

**MODEL #325
230 V.A.C. — 50 Hz
SINGLE INPUT**

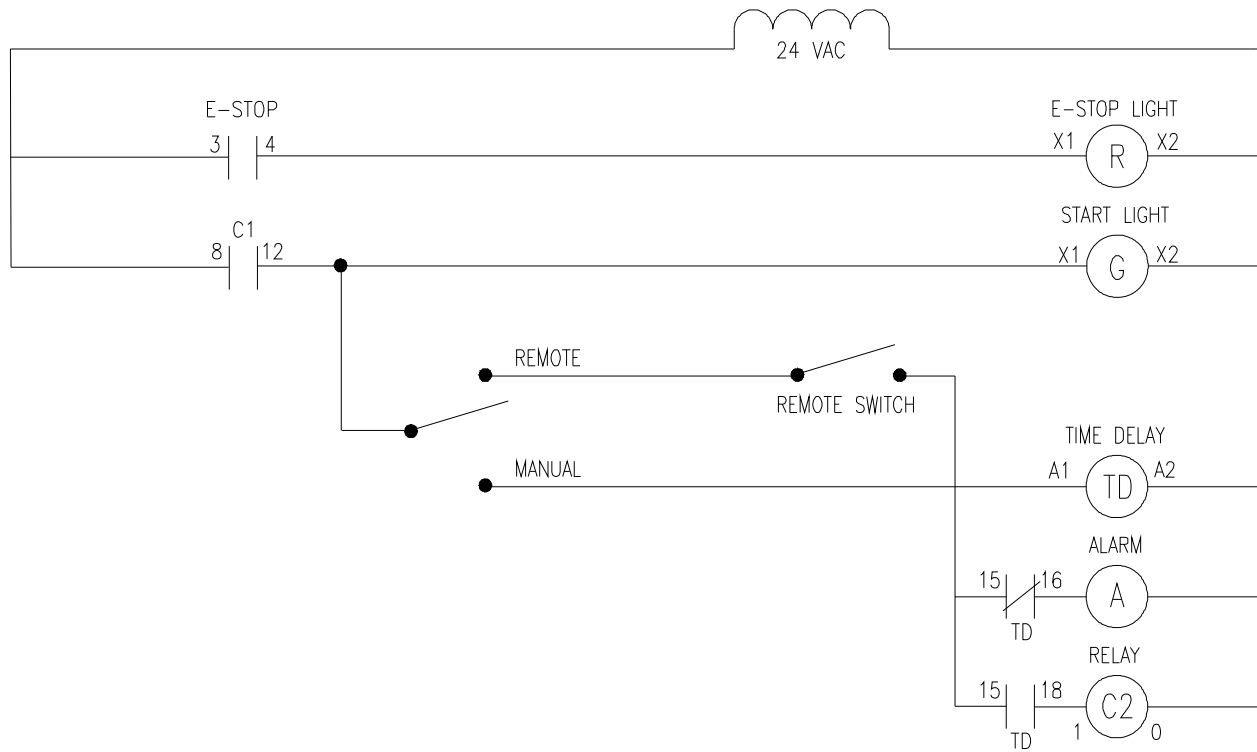
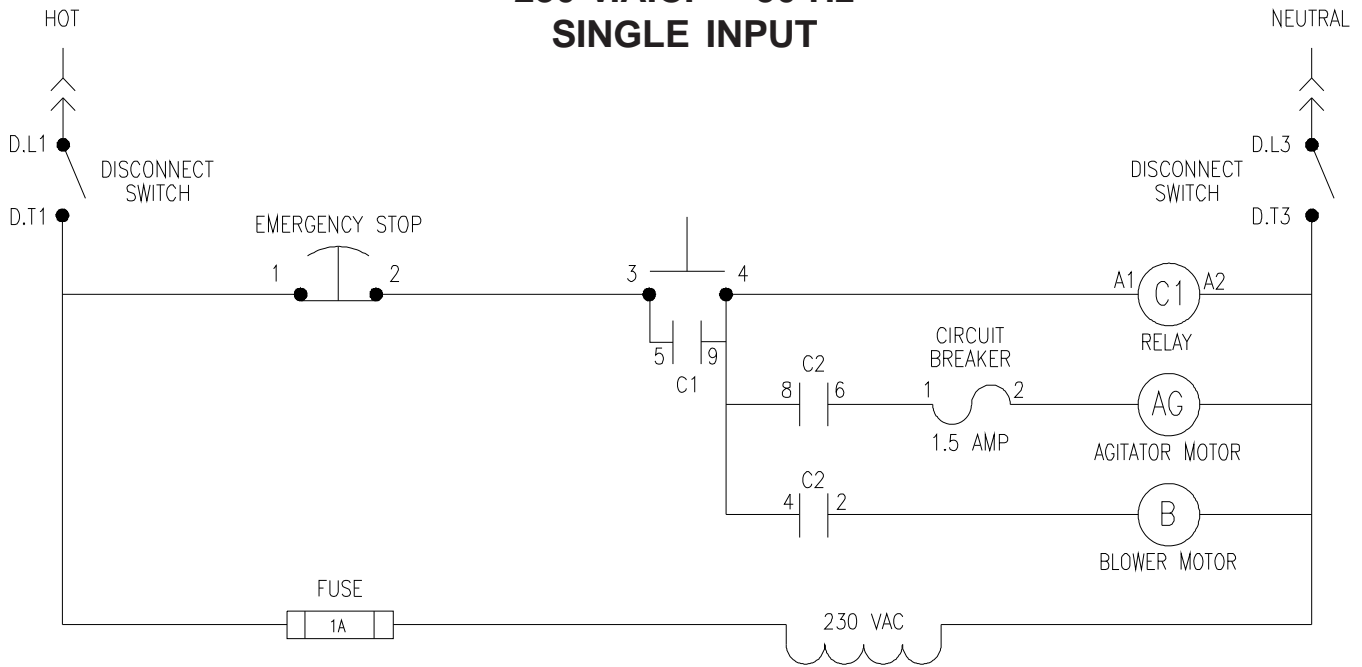

#325 PARTS LIST

Item #	Part #	Description
1	325-1-R3	Base and Hopper
2	325-7-R1	Guard, Chain
3	325-6-R2	Guard, Bottom
4	325-2	Agitator (2)
5-1	1507	Housing, Flange, 3/4", 2-Bolt (8)
5-2	107-1	Bearing, 3/4", Insert Only (4)
6	1506	Seal, Felt, 3/4" (4)
7	4511	#40 Sprocket, 15T x 3/4" (2)
8	448Z	Key, 3/16" x 3/16" x 1" (3)
9	325-3	Airlock w/Rotor
10	426-3	Seal, Airlock, 2-Ply (5)
11	325-5	Cover Plate, Airlock (5)
12	426-7	Seal, Felt, 3/4" (2)
13	426-6	Bearing, 2-Bolt Flange, 3/4" Bore (2)
14	4511-A	#40 Sprocket, 12T x 3/4"
15	325-13	#40 Chain, 46" Long
16	432	#40 Sprocket, Idler, 17T x 5/8"
16-1	FSB120	Shoulder Bolt, 5/8" x 3/4"
16-2	40052	Nut, 1/2-13 x 1" Square
17	422-ASSY	Gearmotor, 1/6HP, 120V (US)
17	422-ASSY-CE	Gearmotor, 1/6HP, 230V (Overseas)
18	325-10	#40 Sprocket, 15T x 5/8"
19	408-A	Blower Motor, 8A, 120V, 60Hz.
19	408-C	Blower Motor, 4A, 230V, 50Hz.
20	409-C	Spacer, Blower 2" (3)
21	337	Clamp, Hose, 2" (3)
22	42518-5	Hose, 2" Dia., 15" Long
23	42562	Filter, 6 1/4" x 6 1/4"
24	325-SE	Panel, Electrical, Complete, 120V 60Hz
24-1	325-E-US	Panel, Electrical, Complete, 120V 60Hz
25	325-E-OS	Panel, Electrical, Complete, 230V 50Hz
26	325-8	Axle
27	FSB078	Pin, Cotter, 1/8" x 1" (2)
28	W-9	Wheel, 9" Pneumatic (2)
29	FW019	W 3/4" Flat Washer SAE (4)
30	250600-4	Aluminum Handle
31	543-M-17	Connector, Cord, Liquid Tite, 1/2" Blue (Overseas)
32	14-3 SJ	Wire, 14-3 SJ (Overseas)
33	ELU06-9	Plug, European (Overseas)
34	RC395A-B	RC Cord Assy, 100', Style B (Overseas)
35	RC395-DPDT	RC Service Kit (DPDT)
35-1	RC395-1	Switch Housing
35-2	RC395-2	Switch Housing Cover with belt clip
35-3	1536-7	Belt Clip
35-4	109066-9	Switch, Toggle, DPDT
35-5	RC395-3	Strain Relief
35-6	RC395-4	8-16 Plastite Screws (4) (Not Shown)
36	18-3 SJ	Wire, 18-3 SJ (100')
37	126-B	Plug, NEMA# 6-15P
38	CV101	Check Valve, 2"
--	199	Link Master, #40 NP

**ELECTRICAL PARTS LIST
120 V.A.C. 60 Hz. S.I.
(BASIC)**

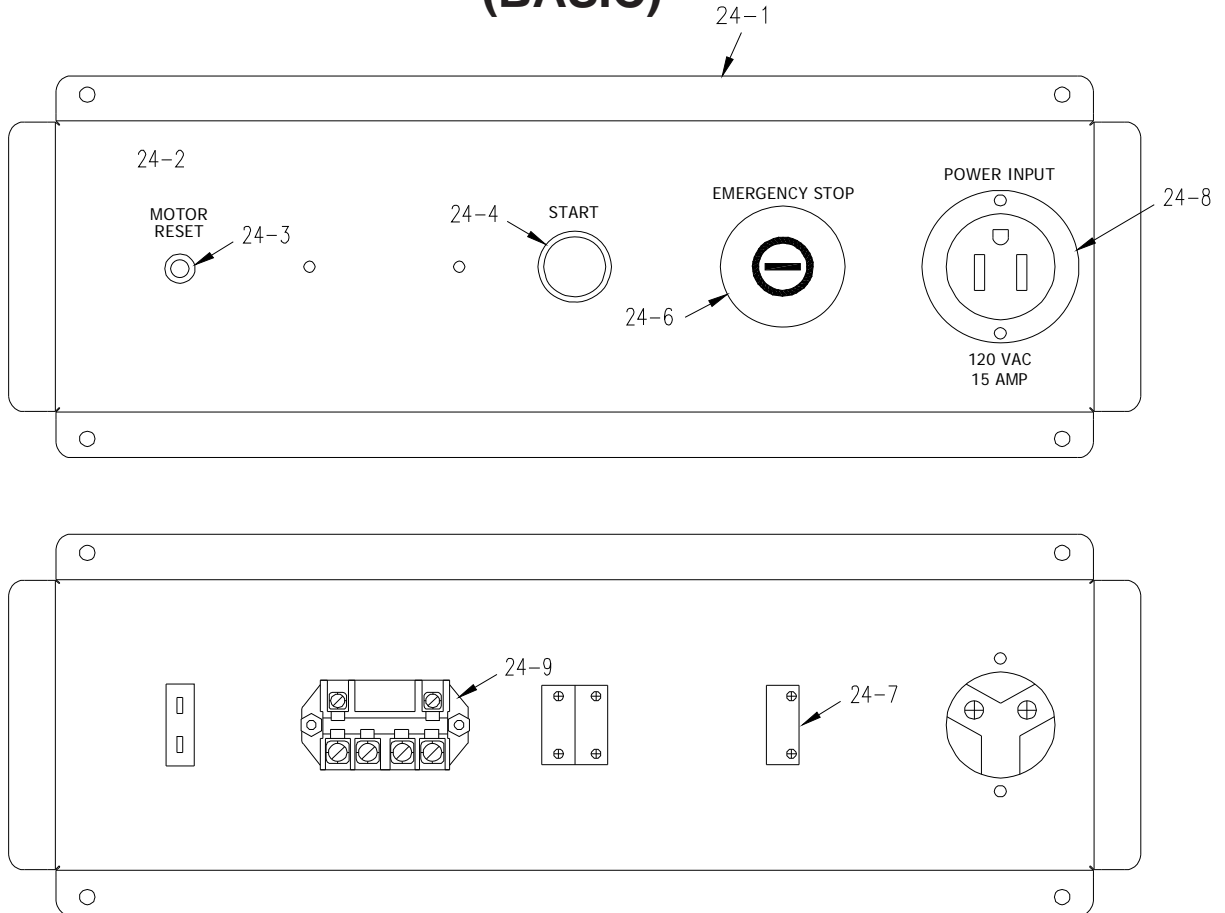

Electrical Exploded Parts List

Item#	Part#	Description
24-1	325-27	Panel, Electrical
24-2	KMC-221	Decal, 325 U.S. On/Off
24-3	433-A	Manual Reset, 2.5 Amp
24-4	543-M-59	Pushbutton On, Green
24-5	543-M-60	Plate, Legend - Start (Not Shown)
24-6	508-2	Switch, Kill, Red
24-7	8075-1	Contact Block
24-8	42528	Plug Recessed input 5-15P
24-9	ELU10-10	Contact, Relay, 120V Control

ELECTRICAL PARTS LIST
120 V.A.C. 60 Hz. S.I.

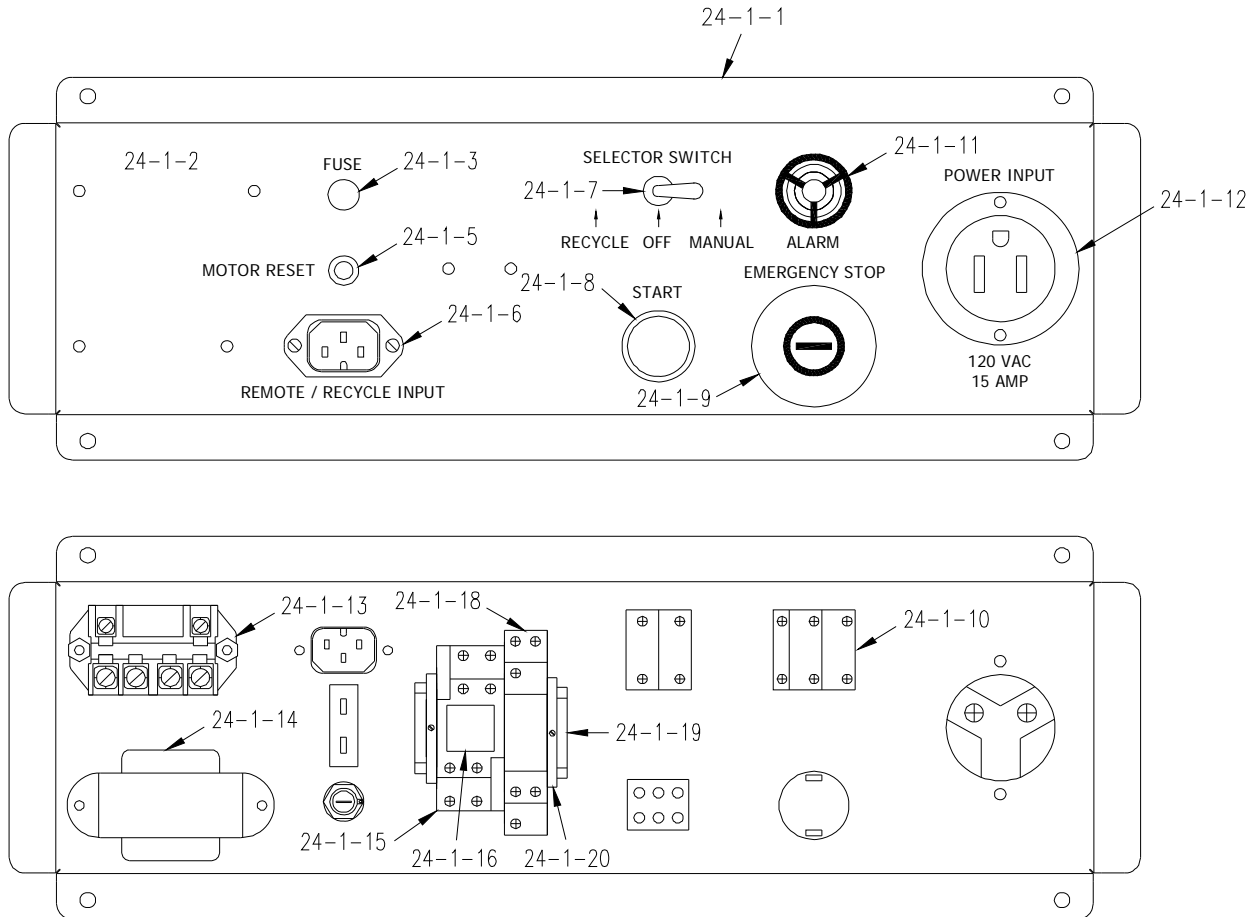

Electrical Exploded Parts List

Item#	Part#	Description	Item#	Part#	Description
24-1-1	325-22	Panel, Electrical	24-1-11	543-M-38	Pre-Alarm System
24-1-2	325-22-D	Decal, 325 Stateside	24-1-12	42528	Plug Recessed input 5-15P
24-1-3	1532	Fuse Holder	24-1-13	ELU10-11	Relay, E-Mech, Control 24V, DPST-NO
24-1-4	1533-A	Fuse, 1/2 Amp, Glass (Not Shown)	24-1-14	1530-C	Transformer, 1 Amp
24-1-5	433-A	Manual Reset, 2.5 Amp	24-1-15	ELU09-4	Socket, 8 Pin Relay 16A
24-1-6	543-M-2	Receptacle, RC, Plug	24-1-16	ELU09-5	Relay, DPDT 120V, 15A
24-1-7	109066-9	Switch, Toggle (DPDT)	24-1-17	ELU09-6	Clip, Hold Down (Not Shown)
24-1-8	543-M-14	Pushbutton On, Green	24-1-18	RELAY-10	Timer / Relay DPDT 12-240VAC 15A
24-1-9	543-M-46	Switch, Kill, Red	24-1-19	ELU07-F	Dinrail, 1 3/8", 2 3/4" Long
24-1-10	8075-2	Contact Block 22mm Green	24-1-20	151080-49	Clamp, F/ 1 3/8" Dinrail (2)

ELECTRICAL PARTS LIST
230 V.A.C. 50 Hz. S.I.

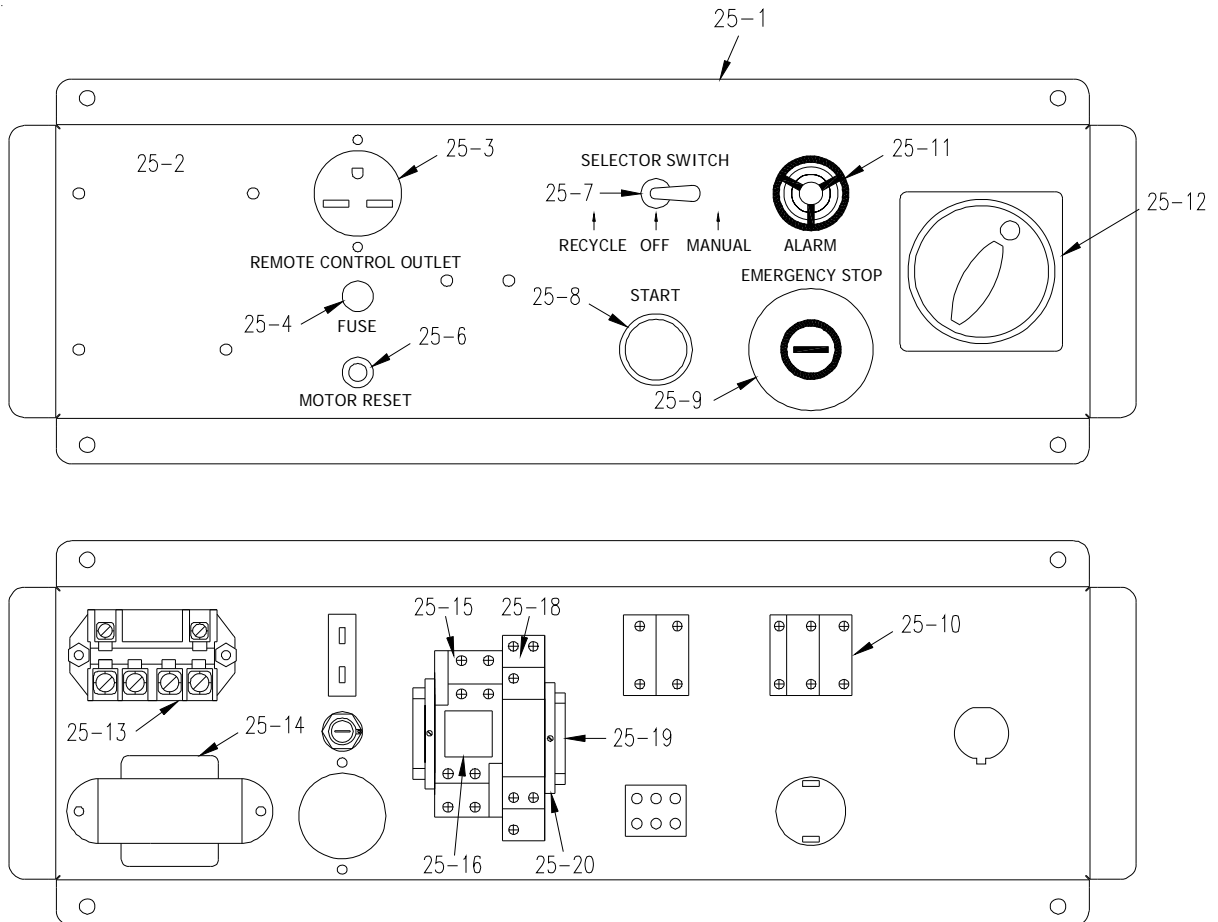

Electrical Exploded Parts List

Item#	Part#	Description	Item#	Part#	Description
25-1	325-23	Panel, Electrical	25-12	54-M-33-OS	Operator Handle Assy
25-2	KMC-222	Decal, Electrical Panel, CE	25-12-1	543-M-85	Switch Disconnect Assy 4P Red
25-3	132-B	Receptacle, NEMA# 6-15R	25-13	ELU10-11	Relay, E-Mech, Control 24V, DPST-NO
25-4	1532	Fuse Holder	25-14	1530-C	Transformer, 1 Amp
25-5	1533-B	Fuse, 1 Amp, Glass (Not Shown)	25-15	ELU09-4	Socket, 8 Pin Relay 16A
25-6	433-A	Manual Reset, 2.5 Amp	25-16	ELU09-325	Relay, DPDT 230V, 10A
25-7	109066-9	Switch, Toggle (DPDT)	25-17	ELU09-6	Clip, Hold Down (Not Shown)
25-8	543-M-86	Pushbutton On, Green	25-18	RELAY-10	Timer / Relay DPDT 12-240VAC 15A
25-9	543-M-87	Switch, Kill, Red	25-19	ELU07-F	Dinrail, 1 3/8", 2 3/4" Long
25-10	8075-2	Contact Block 22mm Green	25-20	151080-49	Clamp, F/ 1 3/8" Dinrail (2)
25-11	543-M-38	Pre-Alarm System	25-21	ELU10-13	Cover, E-Mech Relay (Not Shown)

GLOSSARY

BRIDGING	Tendency of insulation to cling in the hopper forming an air pocket above the airlock. This hinders the normal feeding process of the machine.
CFM	(Cubic feet per minute). A measurement of volume or quantity of air flowing at a certain rate, or air moving capability, of a blower. It is the volume of air moved per minute. Higher volume provides increased coverage and velocity of insulation as it leaves the hose.
COVERAGE	Refers to the amount of insulation coverage, usually measured in square feet, according to the R-value desired. This information is given on the insulation package.
PSI	(Pounds of pressure per square inch). The force exerted on a surface by air/liquid. High-pressure blowers push the insulation through the hose. Higher pressure provides less hose plugging and increased compaction in side wall.
PRODUCTION RATE	Pounds of insulation blown per hour.
RPM	(Revolutions per minute). Speed at which the shaft of a rotating device (i.e. blower fan, agitator) is moving.
R-VALUE	Resistance value. A precise measurement of the insulation's resistance to heat transfer. The higher the resistance value, the slower the heat will transfer through the insulating material.
SETTLED DENSITY	The point at which the insulation will not continue to settle further. Any insulation blown will have a certain amount of progressive settling that occurs after a period of time. Following the insulation manufacturers recommendations for bag rate coverage will provide useful information to accommodate for settling.
SETTLING	Compression or compaction of insulation fibers caused by the weight of the material, vibration of structure, temperature, and humidity cycles.

SERVICE RECORD

DATE	MAINTENANCE PERFORMED	COMPONENTS REQUIRED



50 YEARS OF QUALITY AND SERVICE

Made in the U.S.A.

**KRENDL MACHINE COMPANY • 1201 SPENCERVILLE AVE
DELPHOS, OHIO 45833 • TELEPHONE 419-692-3060 • FAX 419-695-9301
E - MAIL: krendl@krendlmachine.com • WEB SITE: www.krendlmachine.com**
